

Summary of DP2 Lasers and Plan for P5 Commission

The Caltech Laser Team

March 10, 2014

Status of the 2nd DP2 Laser System

- Kejun visited Caltech in December 2013, and installed a new laser control and DAQ software in a CERN desktop PC.
- A long term test at full power (51 A) was carried out successfully with the new DAQ for 350 hours.
- The DAQ was installed in a CERN supported rack-mounted PC (Dell R720) with a PCIe to PCI converter and a fast PCI digitizer card in the PC.
- Second long term test is on-going, and will be completed early next week before shipping the laser to CERN.

2nd DP2: Pulse Energy/Stability vs Pump Current

- Specifications (> 1 mJ) reached with diode pump current > 45 A
- Specifications for width (< 30 ns) reached with pump current > 23 A
- Specification for stabilities of energy (< 3%), width (< 3%) and Jitter (< 3 ns) are met for all pump current settings

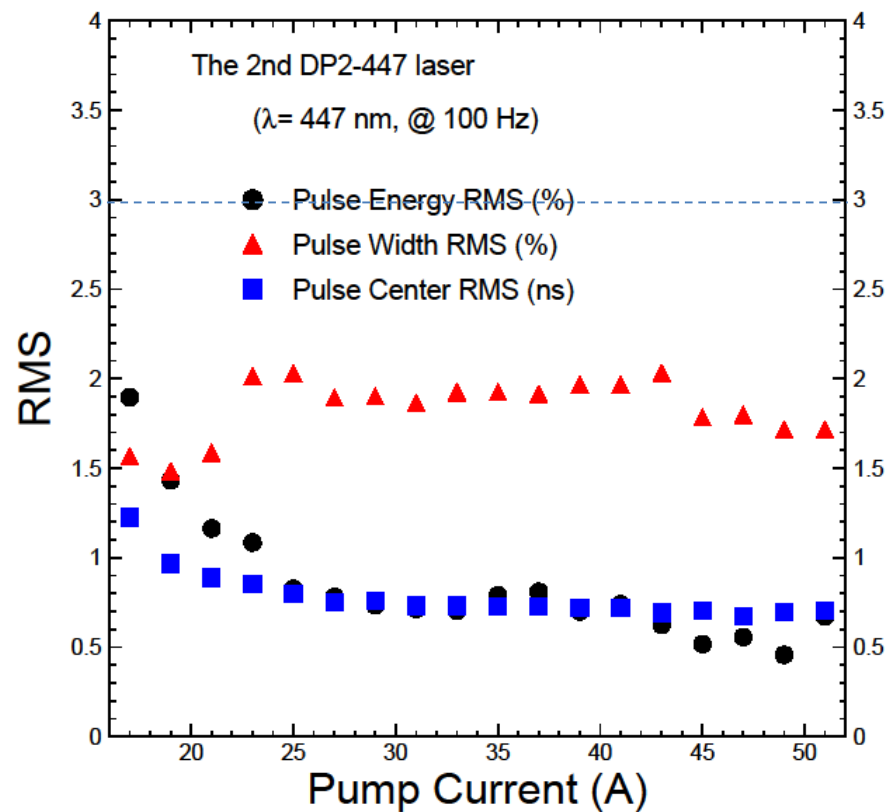
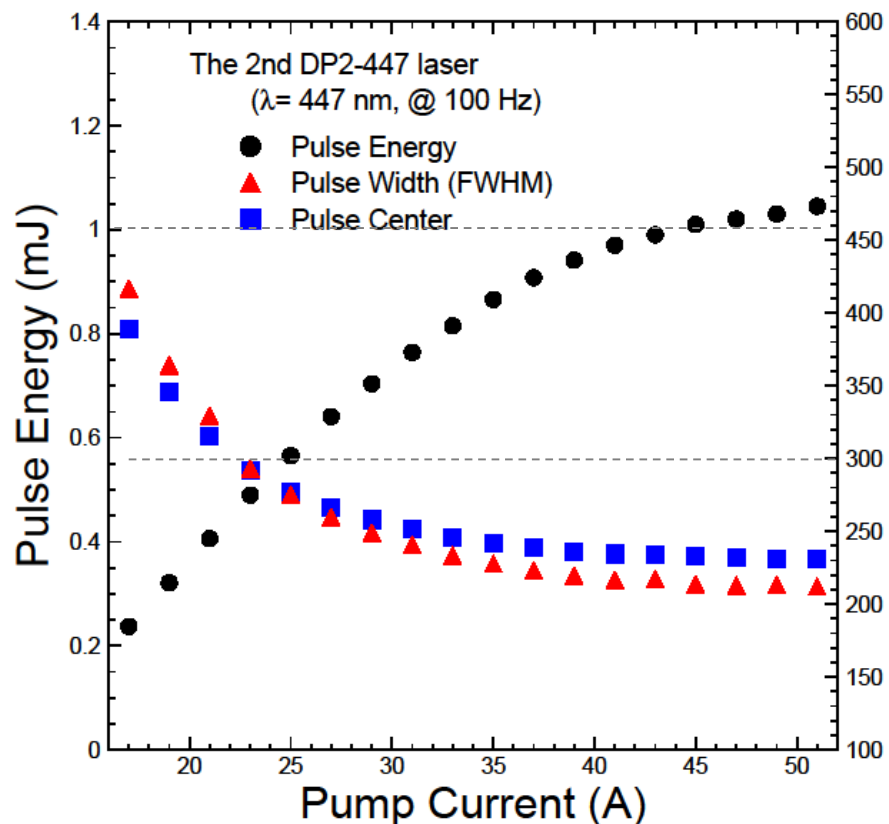

Measured at Caltech, January 2014

1st DP2: Pulse Energy/Stability vs Pump Current

- Specifications (> 1 mJ) reached with diode pump current > 39 A
- Specifications for width (< 30 ns) reached with pump current > 22 A
- Specification for stabilities of energy (< 3%), width (< 3%) and Jitter (< 3 ns) are met for pump current > 24 A

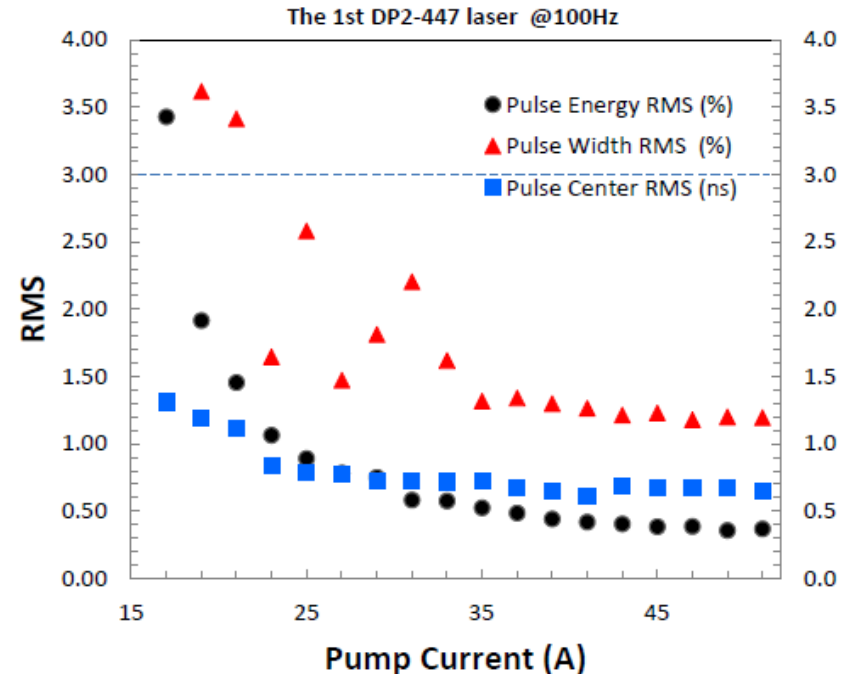
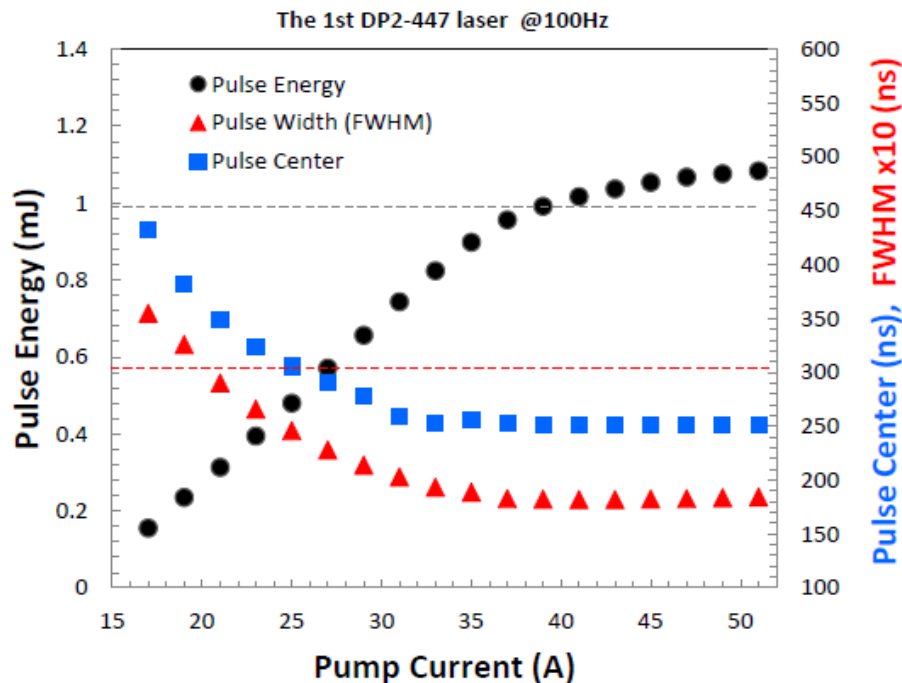

Measured at CERN, January 2014

Long Term Test of the 2nd DP-2 in Full Power

No damage or degradation observed in fiber and ancillary optics

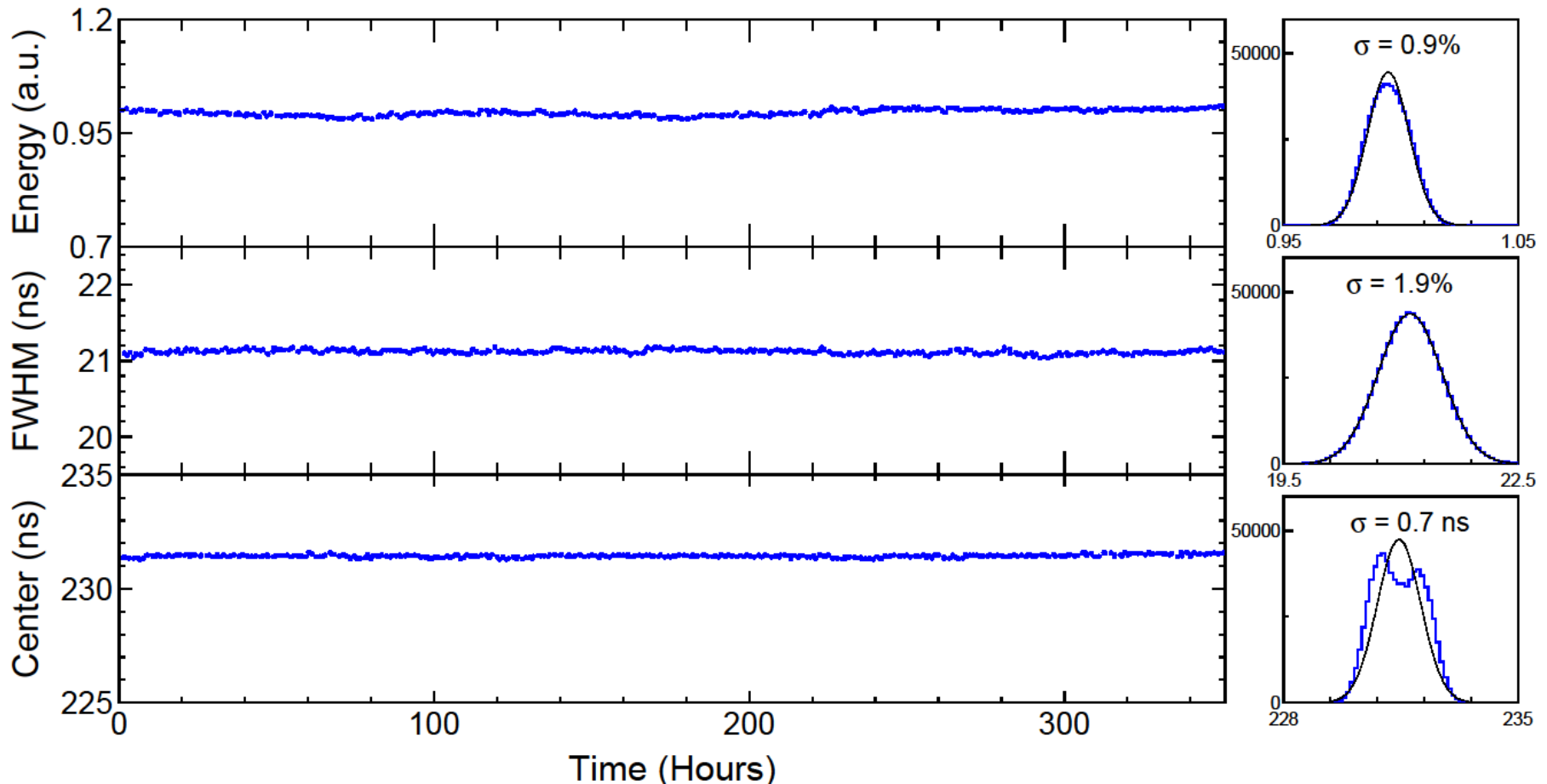

2nd DP2: Pulse Energy Versus Room Temperature

Pulse energy was found correlated to the room temperature with a slope 4%/°C, similar to 3%/°C observed for the 1st DP2

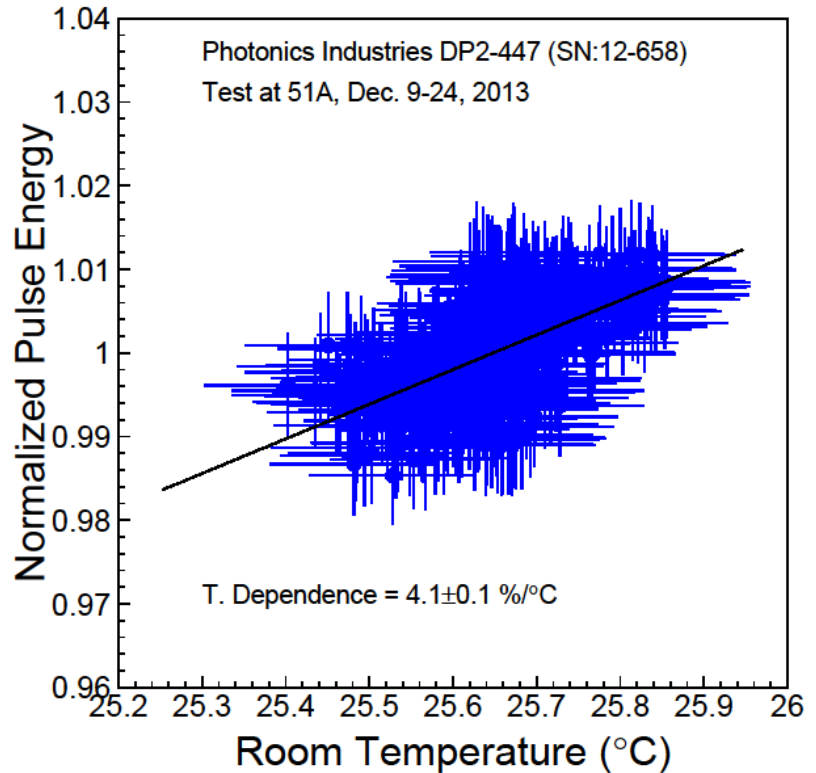
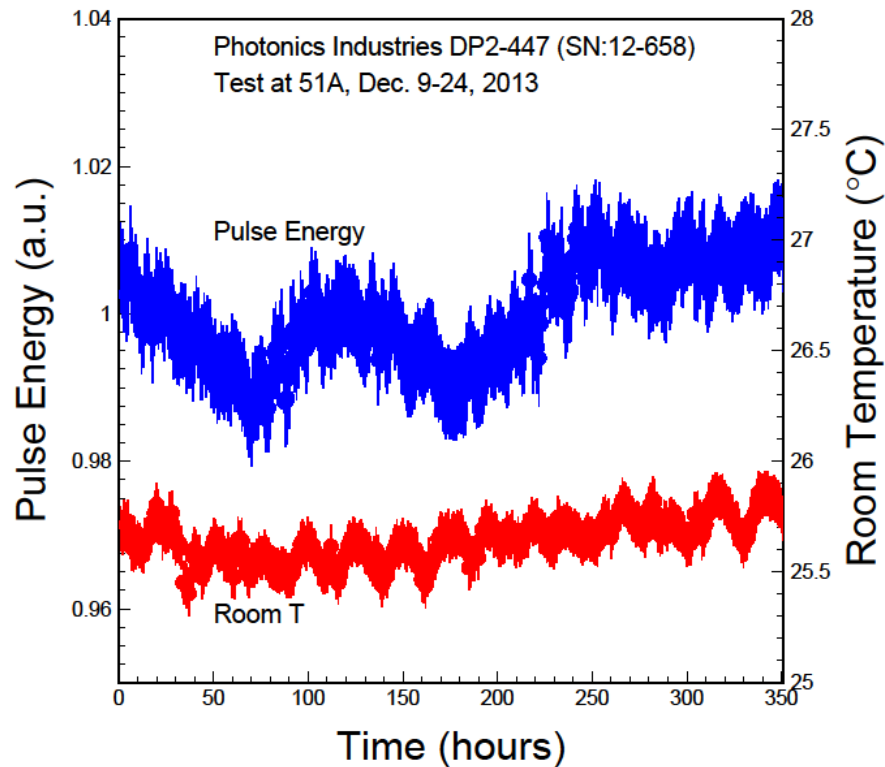

1st DP2: Pulse Energy Versus Room Temperature

Pulse energy was found correlated to the room temperature with a slope of about 3%/°C

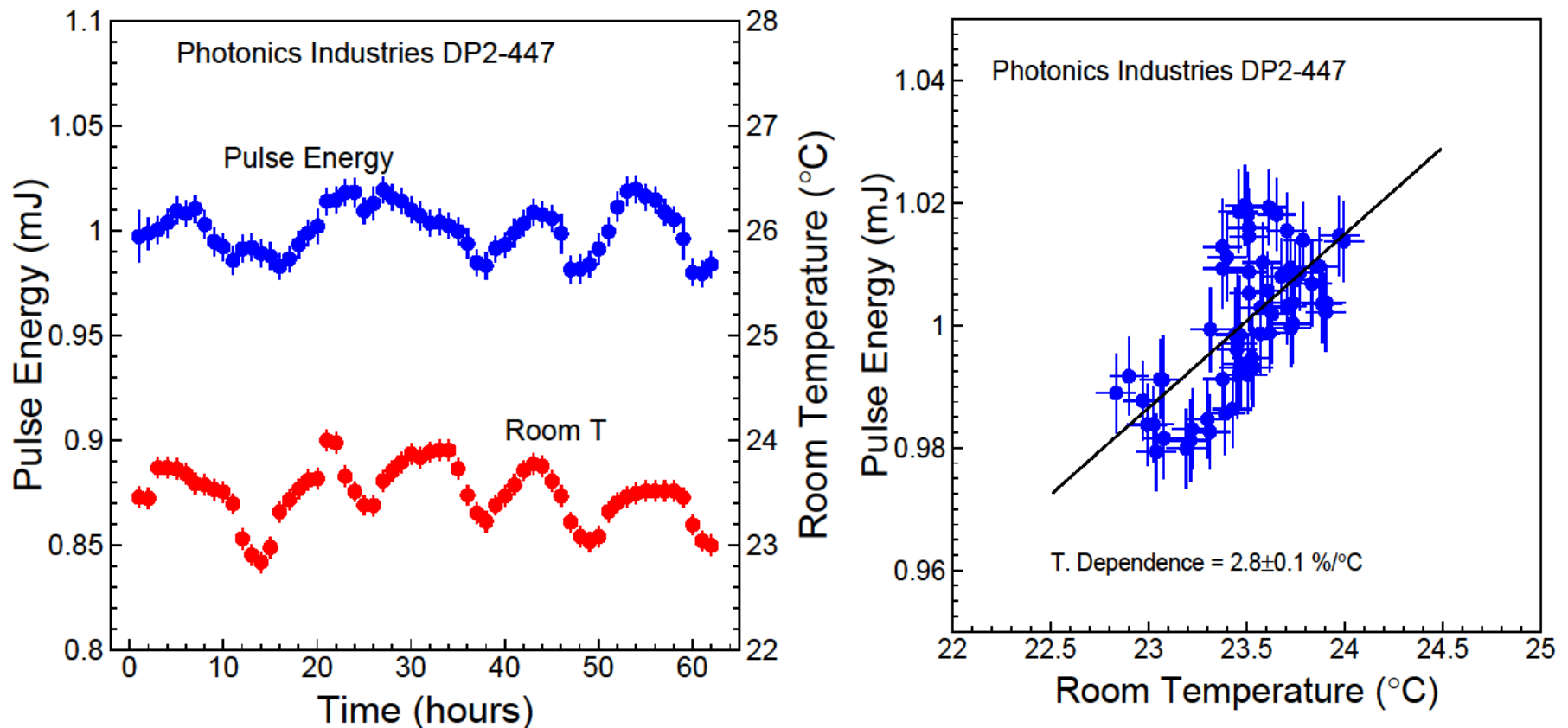

2nd DP2: Width/Timing vs Room Temperature

Laser pulse width and center were found independent of the room temperature, consisting with the 1st DP2

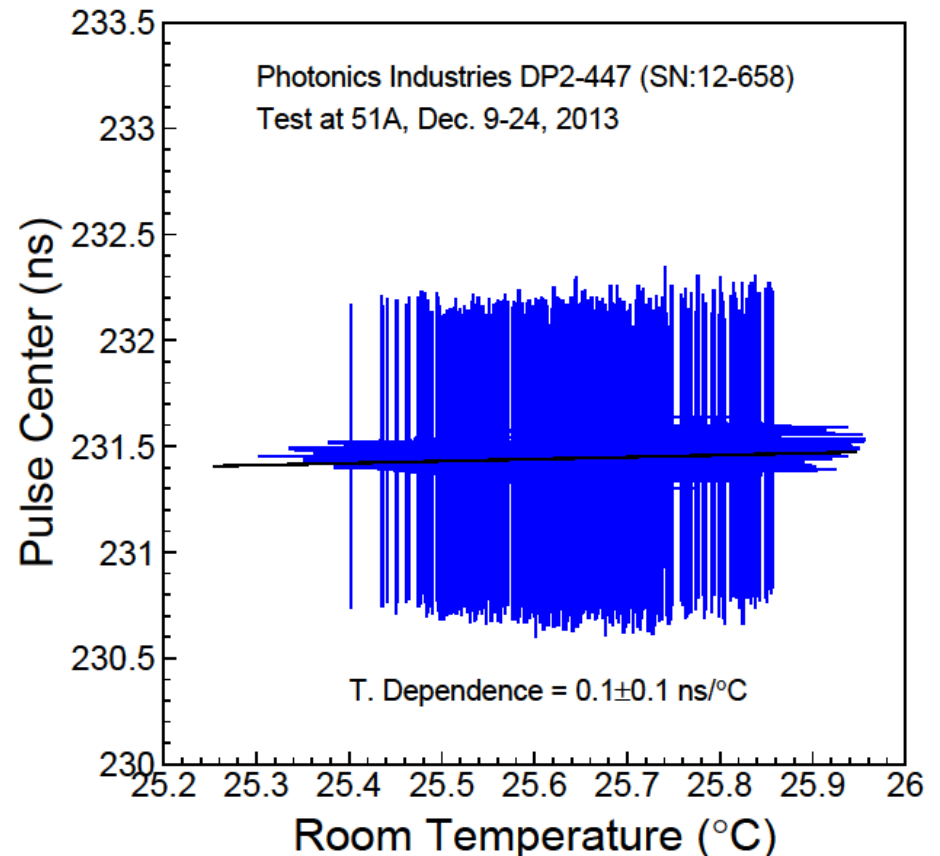
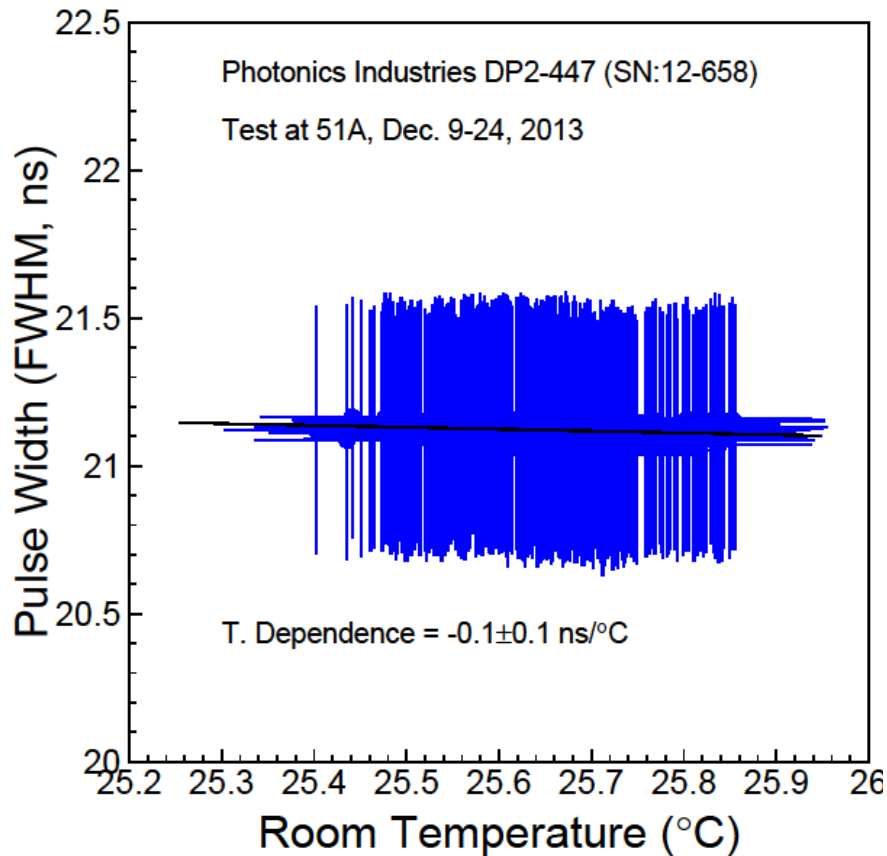

1st DP2: Width/Timing vs Room Temperature

Laser pulse width and center were found independent of the room temperature

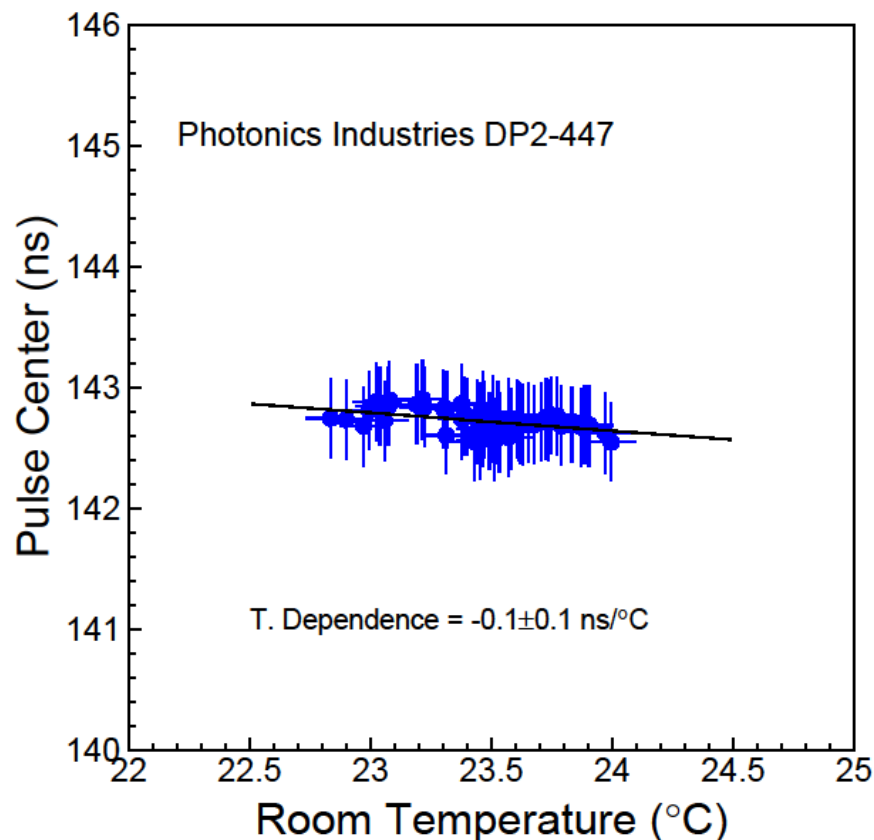
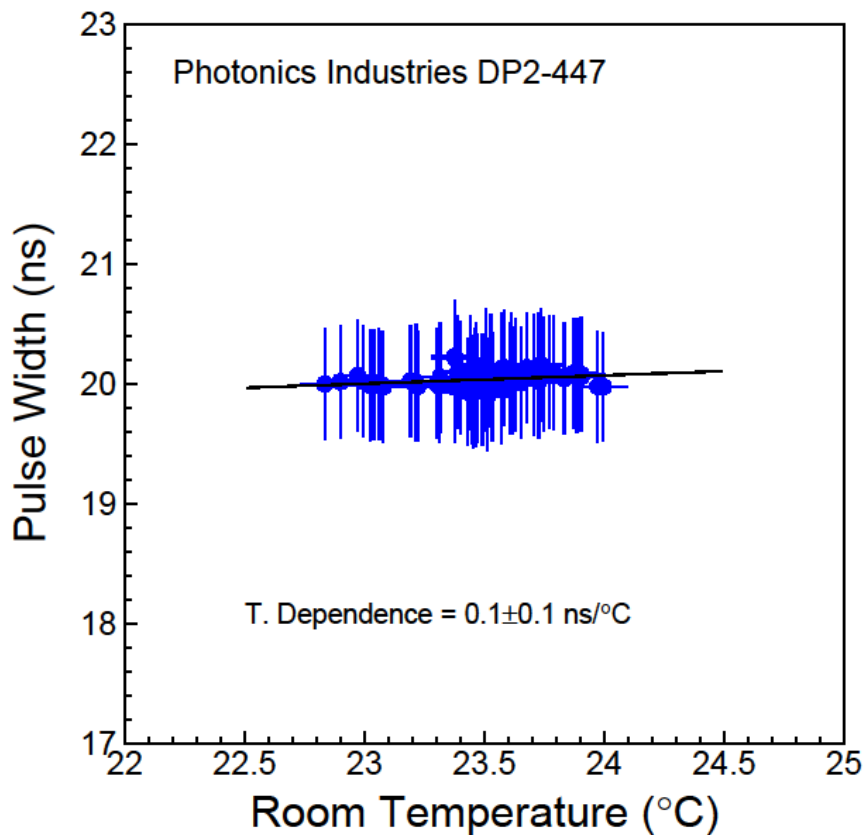

Plan for Three Lasers at P5

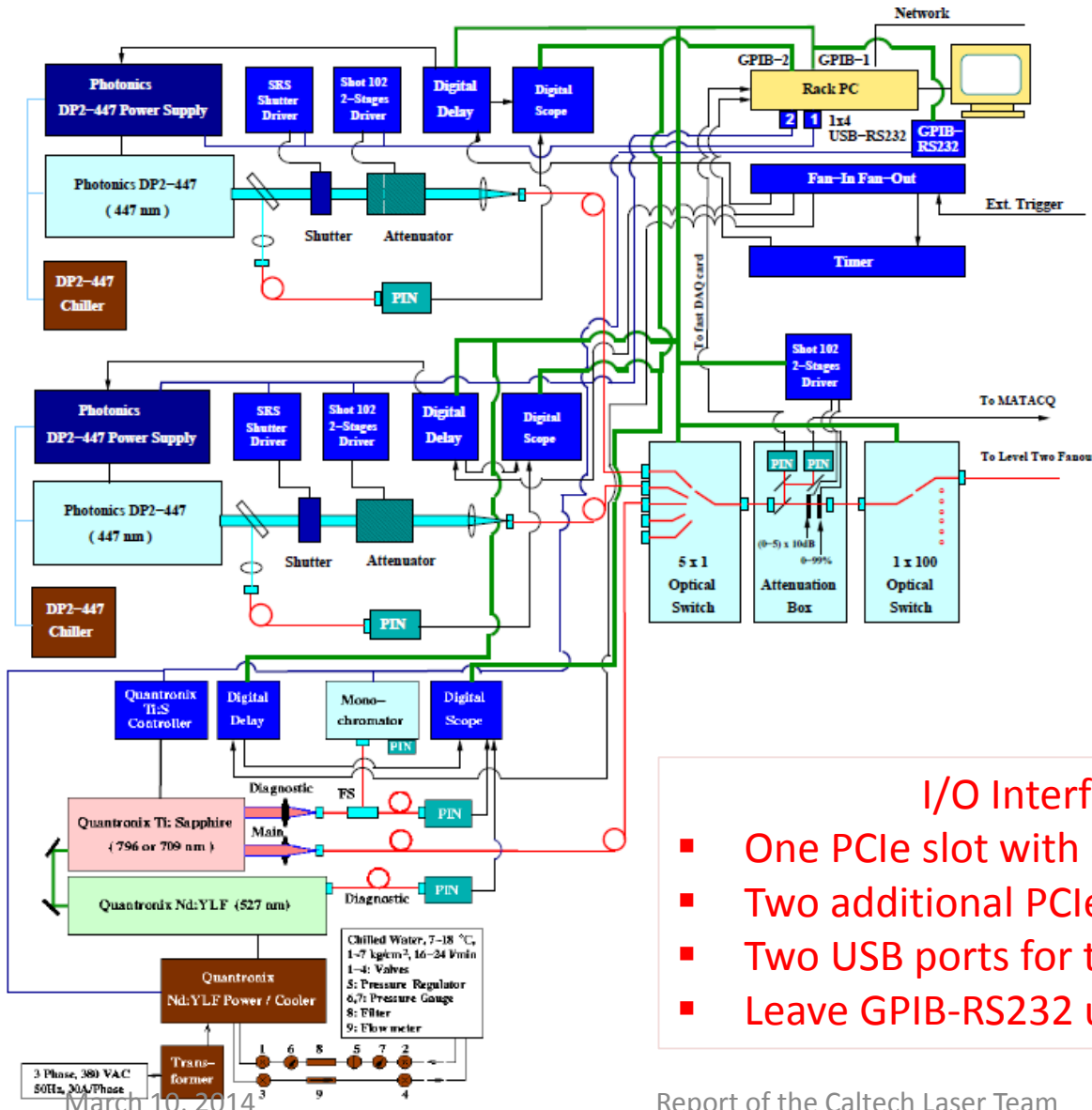

Two DP2 Blues & One Quantronix IR

Three PCs were used in 2012 for slow and fast monitoring and the 1st DP2. They are replaced by one racked mounted standard PC Dell R720 supported by CMS.

- I/O Interfaces for Three Lasers
- One PCIe slot with a convertor to PCI for fast monitor
 - Two additional PCIe slots for PCIe-GPIB
 - Two USB ports for two DP2 1 x 4 USB-RS232
 - Leave GPIB-RS232 unchanged for the IR

New Laser Software

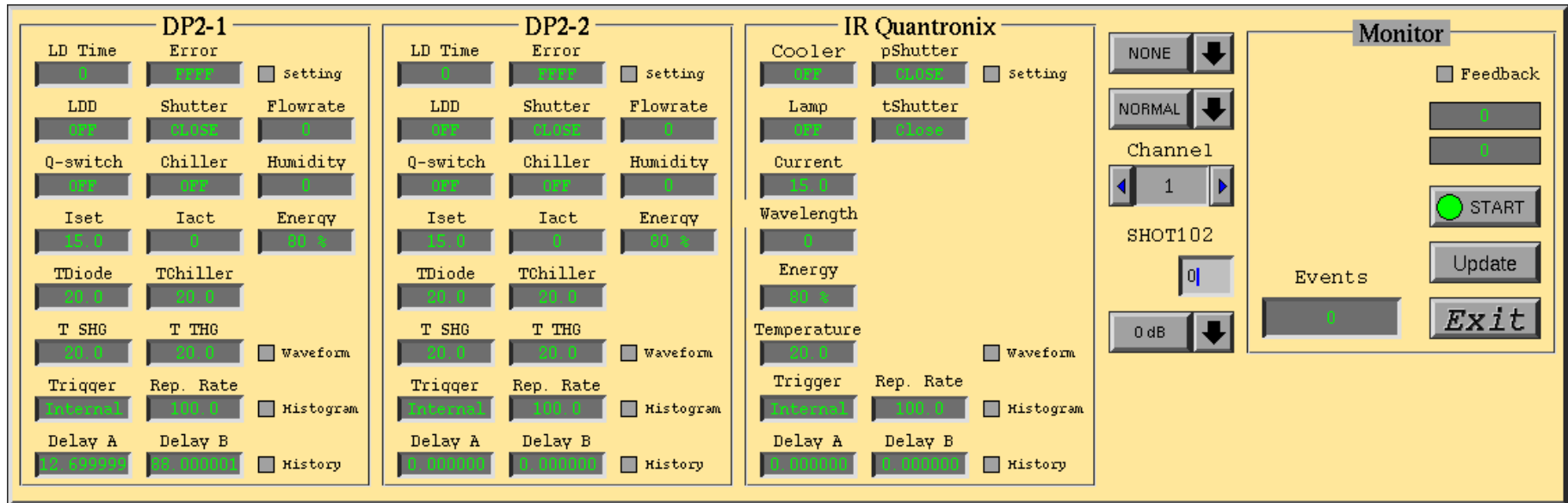

- Redesigned laser control software to control two DP2 + one IR laser
- Redesigned GUI to display the laser information as much as possible
- Replaced GPIB to RS232 with USB to RS232 for DP2 lasers
- Implemented automatic alarm e-mail notice to a list
- Tested for the 2nd DP2 with a rack-mounted PC Dell R720

Summary

- Both DP-2 lasers meet specifications. A long term test of 350 hours shows stabilities of 1%/2%/1 ns for laser pulse intensity/width/timing.
- Temperature coefficient of the pulse intensity was measured to be 3 and 4% respectively for the 1st and 2nd laser. No T dependence was found for width and timing.
- A new laser control and DAQ software was tested in a CERN supported rack-mounted PC Dell R720 which will replace three PCs used during LHC Run I.
- Commissioning at P5 is scheduled from April 2 to 7.