



Plan for the ECAL Monitoring Laser System

The Caltech Laser Team
CMS Week, CERN

April 10, 2013



Outline



- Laser Barrack
- Laser Control and Rack PC
- Lamp Pumped Quantronix IR laser
- Photonics DPSS (DP2-447) Lasers



Laser Barrack at P5

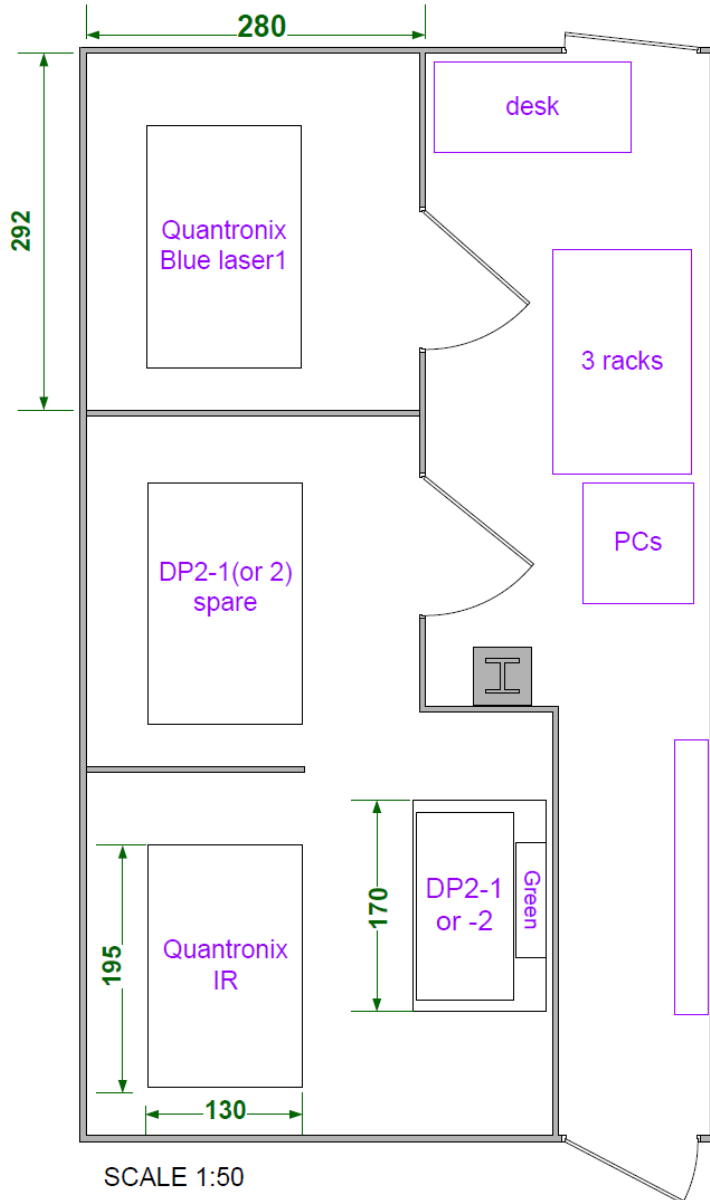

Work plan

- Modify the safety box and interlocks
- Dismount the Quantronix Laser-2
- Installation and/or reorganization of cables and fibers.
- Re-organization of the spare units and parts.
- Room temperature stabilization and test.



Preliminary Layout of Three Lasers

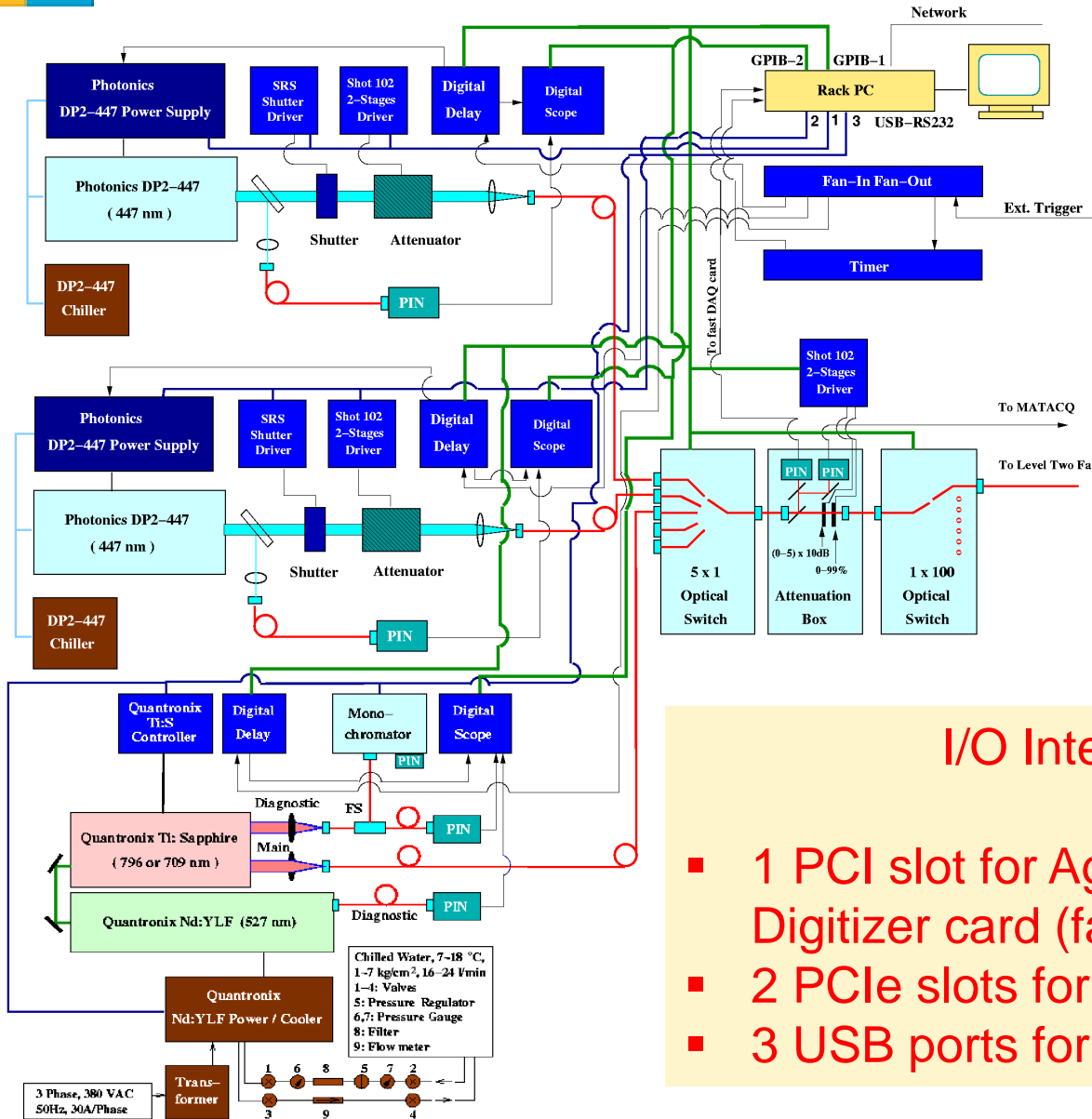

Two DP2 Blues & One Quantronix IR

3 PCs used now for the slow and fast monitoring and the 1st DP2 will be replaced by one racked mounted standard PC supported by CMS.

- ### I/O Interface Needed
- 1 PCI slot for Agilent U1071A-002 Digitizer card (fast monitoring).
 - 2 PCIe slots for 2 PCI-GPIB cards.
 - 3 USB ports for USB-RS232 for 3 lasers,



System Components & Controls



Related to the Requirement to the Rack-Mounted PC

Instrument	Model	GPIO	RS232	USB	LAN	Current Configuration	Solution-1	Solution-2	Comments and other options
Digital Scope	Agilent 6052A	IEEE488.2 500 kb/s	N/A	USBTMC- USB488 3.5 Mb/s	100 Mb/s (TCP/IP) 1 Mb/s	PCI-GPIB-0	PCIe-GPIB-0	USB-GPIB-0 or LAN?	Solution-2 needs to be tested.
Delay Unit	SRS DG535	IEEE488	N/A	N/A	N/A	PCI-GPIB-1	PCIe-GPIB-1	USB-GPIB-1	SRS DG645 with RS232 and LAN: > = 4 x \$4200
Optical Switch	DiCon GP700	IEEE488	Yes	N/A	N/A	PCI-GPIB-1	PCIe-GPIB-1	USB-GPIB-1	RS232 with compromised switching time
Attenuator Controllers	OptoSigma Shot-102	IEEE488	Yes	N/A	N/A	PCI-GPIB-1 USB-RS232	PCIe-GPIB-1 and USB-Rs232	USB-GPIB-1	
YLF Power Supply	Quantronix 527DQ		Yes			PCI-GPIB-1, GPIO-RS232 (ICS 4896)	USB-RS232		
Ti:S Laser	Quantronix Proteus		Yes			PCI-GPIB-1, GPIO-RS232 (ICS 4896)	USB-RS232		
DPSS Laser	Photonics DP2-447		Yes			USB-RS232	USB-RS232		
Fast Monitoring Digitizer	Agilent U1071A-002	N/A	N/A	N/A	N/A	PCI port	1x PCI Port	PCIe-PCI converter (\$100~\$1000)	Solution-2 needs to be tested. Agilent PCIe fast digitizer U1084A-002 > \$12K/each.

Solution-1 needs 1 PCI & 2 PCIe slots. Solution-2 needs 1 PCIe slot



Requirement to the Laser PC



The rack PC will not have 3 x PCI slots, so the following options

- 1) Options 1 requires 1 x PCI plus 2 x PCIe slots and 3 x USB ports. Two NI PCI-GPIB cards will have to be replaced by two PCIe-GPIB cards at \$600/each.
- 2) Option 2 requires 1 x PCIe slot and 5 x USB, so no PCI slot is required. One converter for PCIe to multiple PCI ports is needed. Its Linux driver, speed and reliability etc. will have to be tested. If not successful two Agilent PCI digitizer cards U1071A-002 will have to be replaced by U1084A-002 with PCIe interface at >\$12K/each.
- 3) In addition, NI USB-GPIB will also be tested. If successful, two PCIe ports for the GPIB interfaces will not be needed.



StarTech PCIe to PCI Chassis



PCI Express to 4 Slot PCI Expansion System



4 Full size PCI cards
456 Euros
No Linux driver
Needs to be tested

<http://eu.startech.com/Cards-Adapters/Slot-Extension/PCI-Express-to-Four-Slot-PCI-Expansion-Bay~PEX2PCI4>



Spare Parts for Quantronix IR



The Quantronix IR Laser needs spare parts

#	Description	Part number	In Stock	Unit price \$	Unit price Euros *	Mean Lifetime (hr)	Missing parts LS2	Cost LS2 Euros	Missing parts LS3	Cost LS3 Euros
1	YLF Crystal Rod Assembly	1001-00955	2*	6000	9850	8000	1	9850	3	29550
2	YLF Krypton Arc Lamp	2601-00124	21	265	395	1000	5	1975	24	9480
3	YLF Lamp Jack Assembly 118	0201-03717	22	202.5	260	1000	5	1300	24	6240
4	YLF DI Cartridge filter	72835	13	66.6	135	2000	0	0	13	1755
5	Ti:S Pockel Cell (QS-3)	Quantum tec.	4*	2717	N/A	8000	0	0	1	2100
6	Ti:S HV Pulser (HVP-525-PS)	Quantum tec.	4*	1837	N/A	8000	0	0	1	1500
7	Ti:S-3 Crystal, SCRY-00361	<i>custom made</i>	1	3361		should be reliable				
8	Ti:S-3 Pump Focus Lens, 1105-05438	<i>custom made</i>	1	118		should be reliable				
9	Ti:S-3 Short wave pass filter intra-cavity filter 700nm	<i>custom made</i>	1	3750		should be reliable				
10	Ti:S-3 Pump and output coupling mirror	<i>custom made</i>	0			should be reliable				
11	Ti:S-3 fold mirror	<i>custom made</i>	0			should be reliable				
12	Ti:S-3 cavity end mirrors, x2	<i>custom made</i>	0			should be reliable				
ESTIMATE:								13125		50625

*: Including used parts in dismantled Quantronix blue lasers 1 and 2

*: Price in Euros valid up to April 2013

Excel Europe is the only vendor of the spare parts for Quantronix lamp pumped lasers. 13k/51k Euros are needed for runs after LS1/LS2 respectively.



Report on the Test and Training Session at Photonics

(March 26-28, 2013)

David Bailleux, Liyuan Zhang



Tasks



- 1) Measure the pulse width stability as function of repetition rate for the 2nd DP2, which is a delivery condition as specified in the quotation “Customer will perform a measurement at our facility to verify the specification for stability of the laser pulse width. If the above quoted specification for pulse width stability can not be met, the customer will have the option to cancel the order with no penalty.”
- 2) Training on service and troubleshooting for laser power supply and laser head with a focus on (1) replacement of the laser diodes, (2) diagnostic and replacement of the HV driver, (3) identification of the parts in the laser cavity and (4) fine tuning the end mirror.
- 3) Discussions on issues related to our application, e.g. maintenance of the spare laser etc.
- 4) Check the 1st DP2-447 status and understand the power dropping observed last year during laser runs.

Status of the 2nd DP2-447 Laser

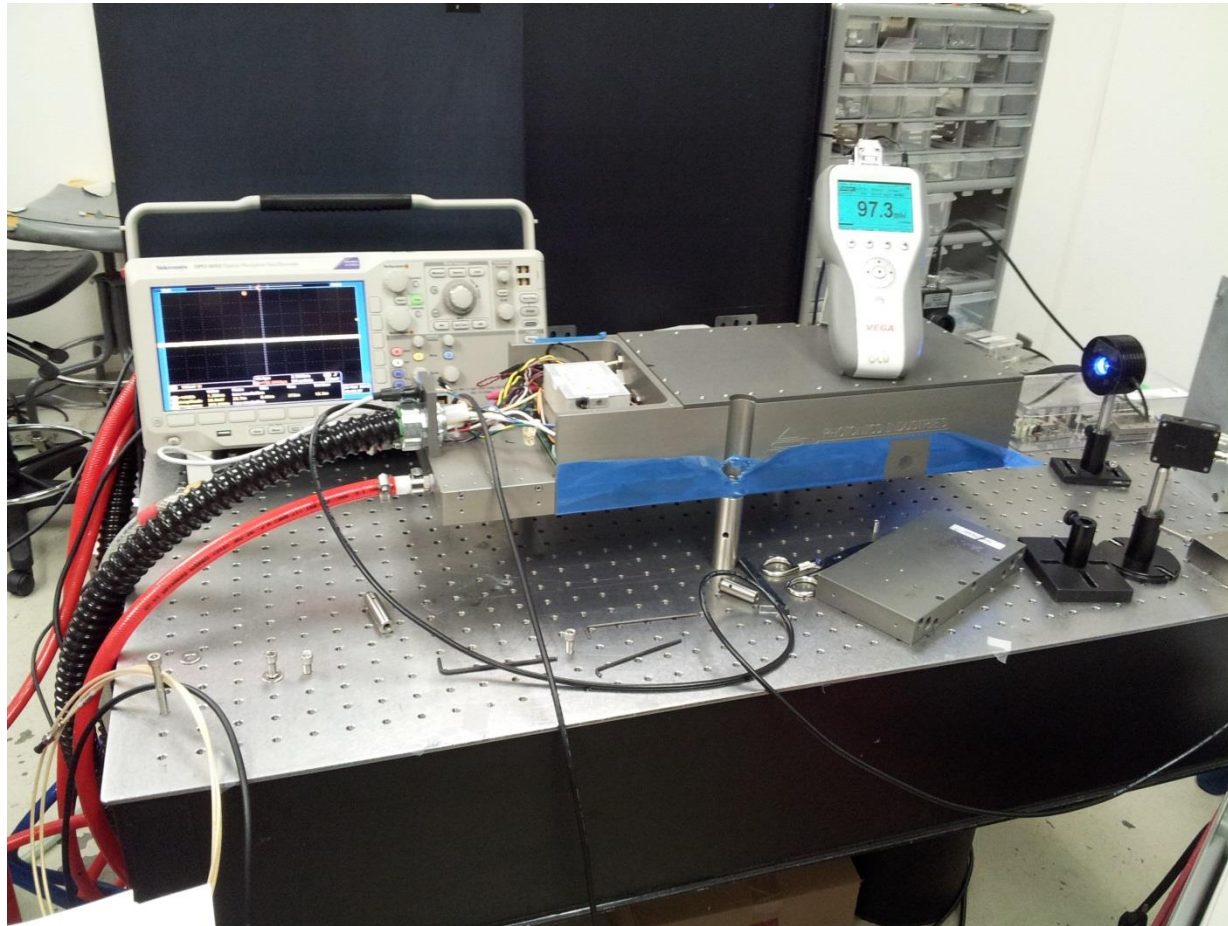

The construction of the laser head is finished. A commercial chiller with both heating and cooling functions was ordered but not yet delivered. The system tested has a temporary chiller.



Pulse Energy of the 2nd DP2 at 100 Hz

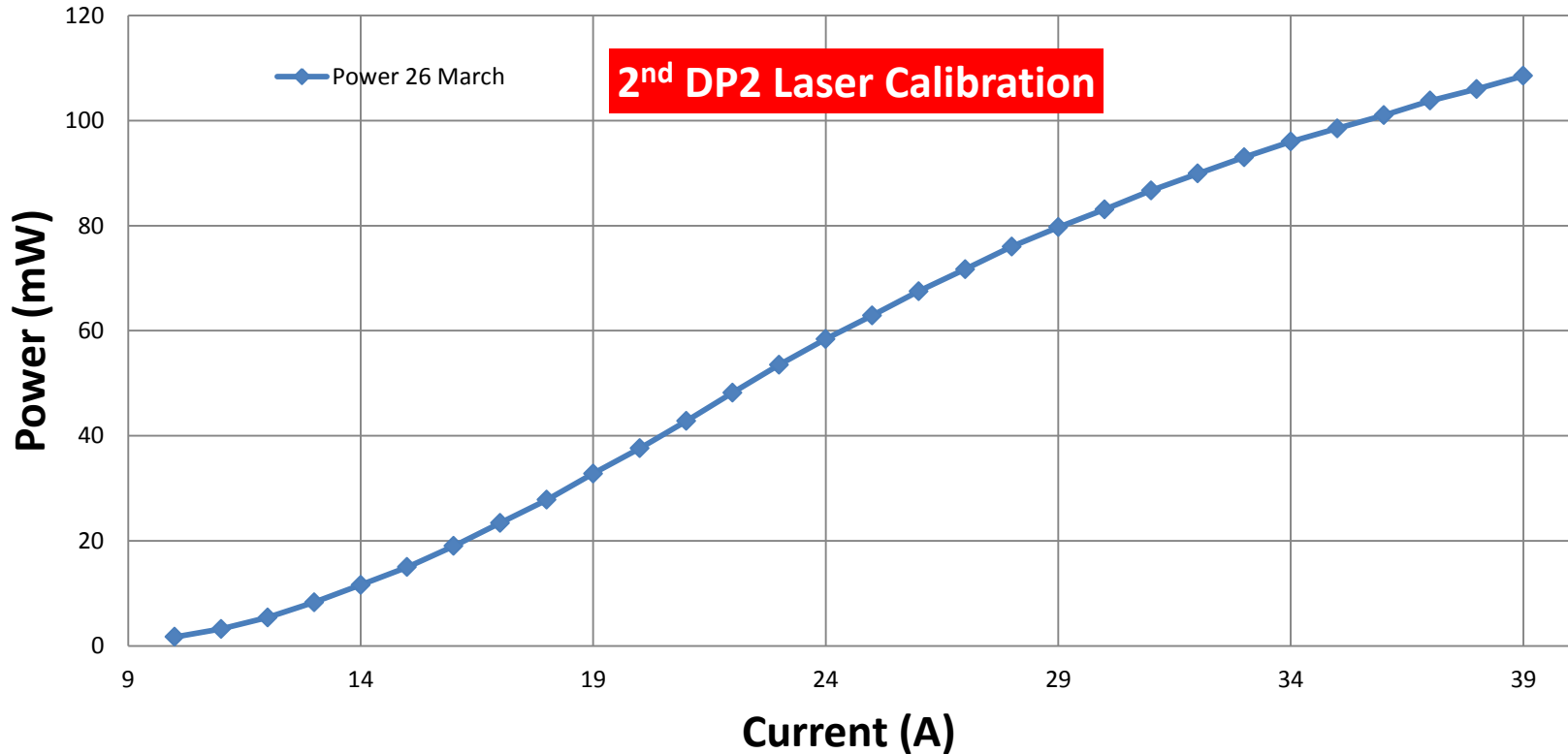

The Pulse energy meets the spec of 1 mJ at 36 A pumping current, indicating that the conversion efficiency from diode to laser pulse at 447 nm is ~1.8x higher than that of the 1st DP2. An explanation given by Photonics is that the emission wavelength of the pumping diodes in the 2nd DP2 has a better matching with the laser crystal absorption band. Further investigation is needed to fully understand this difference.



1st Data on Width Stability for the 2nd DP2



With Thorlabs DET10A Photodiode and Agilent DSO6052A (500 MHz, 2Gs/s) scope, the pulse width of the 2nd DP2-447 was found to be slightly dependent on repetition rate. The rms of ~2.5% however is within the spec of 5%. The result was double checked with a Photonics scope Tektronix DPO 3032 (300 MHz, 2.5 GS/s).

Repetition Rate (Hz)	FWHM (ns) (avg 256)
100	19.9
10	21.4
10	20.9
1	21
100	19.9
100	20
10	20.9
10	21.3
1	21.2
1	20.9
100	20.1
10	20.9
1	20.1
20	20.8
5	21.2
50	20
40	20.4
30	20.6
Avg (ns)	20.6
RMS (%)	2.5

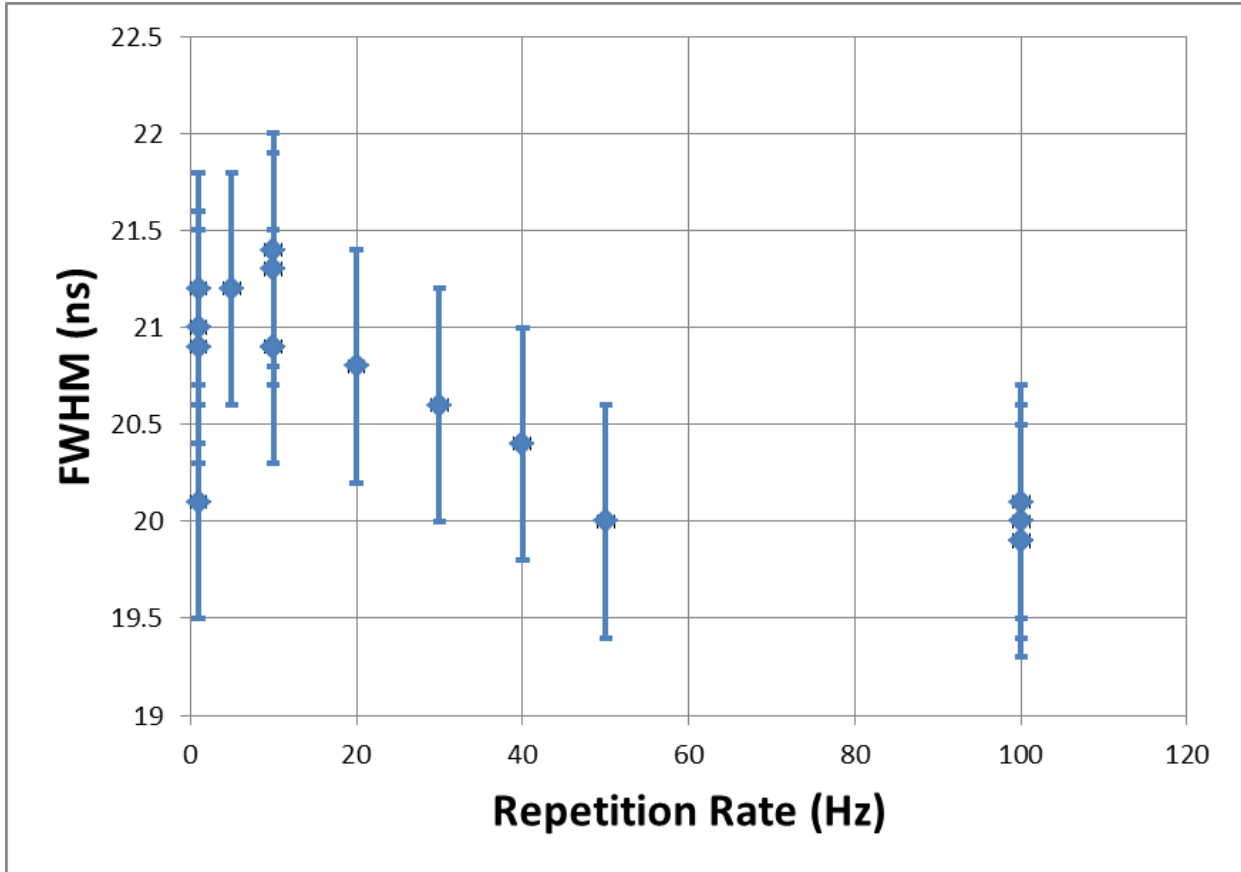

2nd Data on Width Stability for the 2nd DP2

After a discussion, Graham Ross fine tuned the cavity end mirror in the 2nd DP2. We measured the pulse width again for both lasers with the Tektronix DPO3032 and found they are consistent and independent of the repetition rate. This result is consistent with what we measured for the 1st DP2 last year at Photonics.

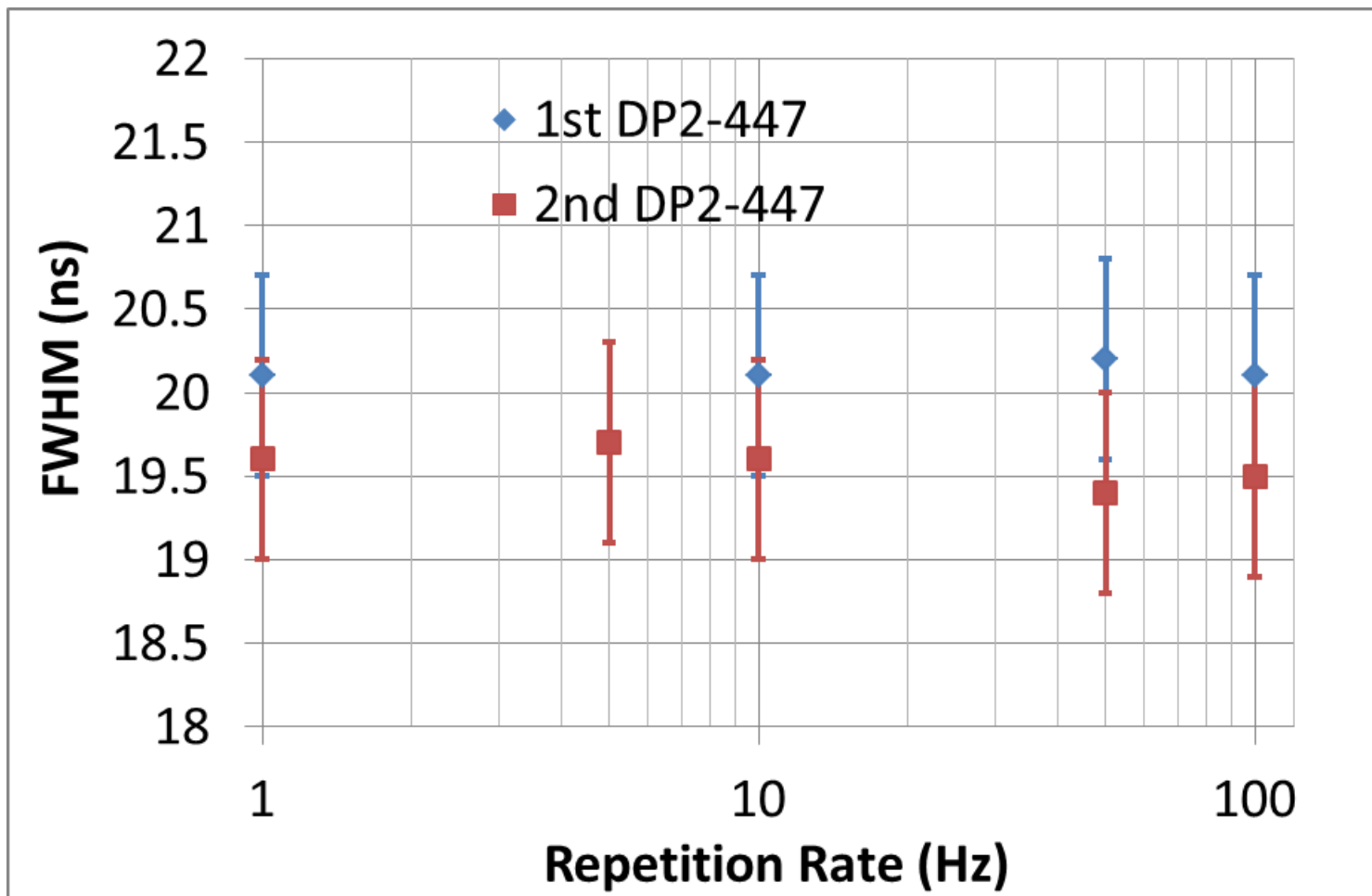

Pulse Jitter of the 2nd DP2 at 100 Hz

The pulse jitter was measured as the rms of the delay from the Q-switch trigger to the rise edge of laser pulse (Ch2->Ch1). The observed jitter is less than 1 ns, which is consistent with the 1st DP2.

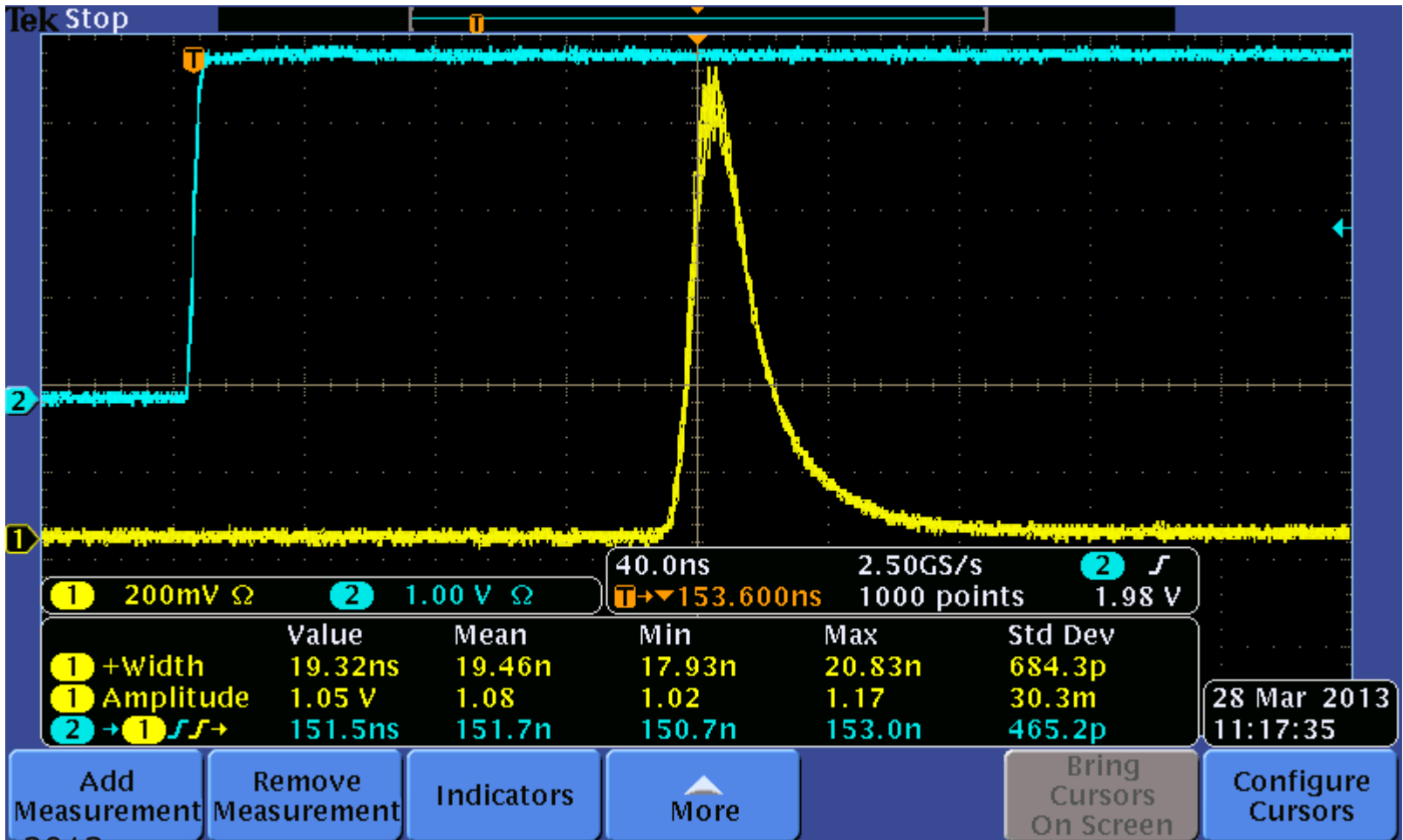

Status of the 1st DP2 (I)

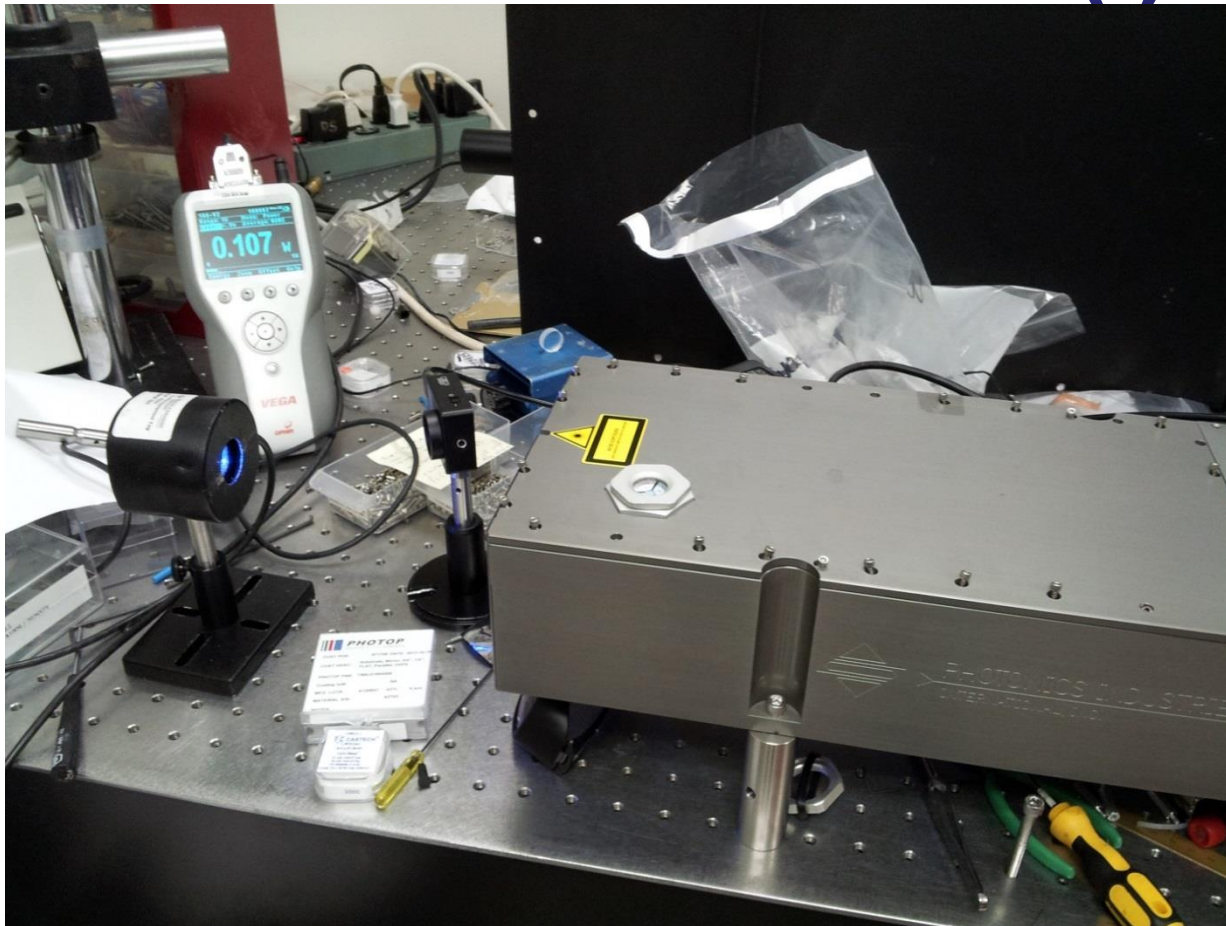

The cavity was checked at Photonics. The THG crystal was found to have a damaged coating. The coating was believed to be reliable, so this damage is probably an occasional incident. A new type of THG crystal, which is supposed to be more reliable, is installed and being tested. If it works, Photonics may also replace the THG crystal in the 2nd DP2.

Status of the 1st DP2 (II)

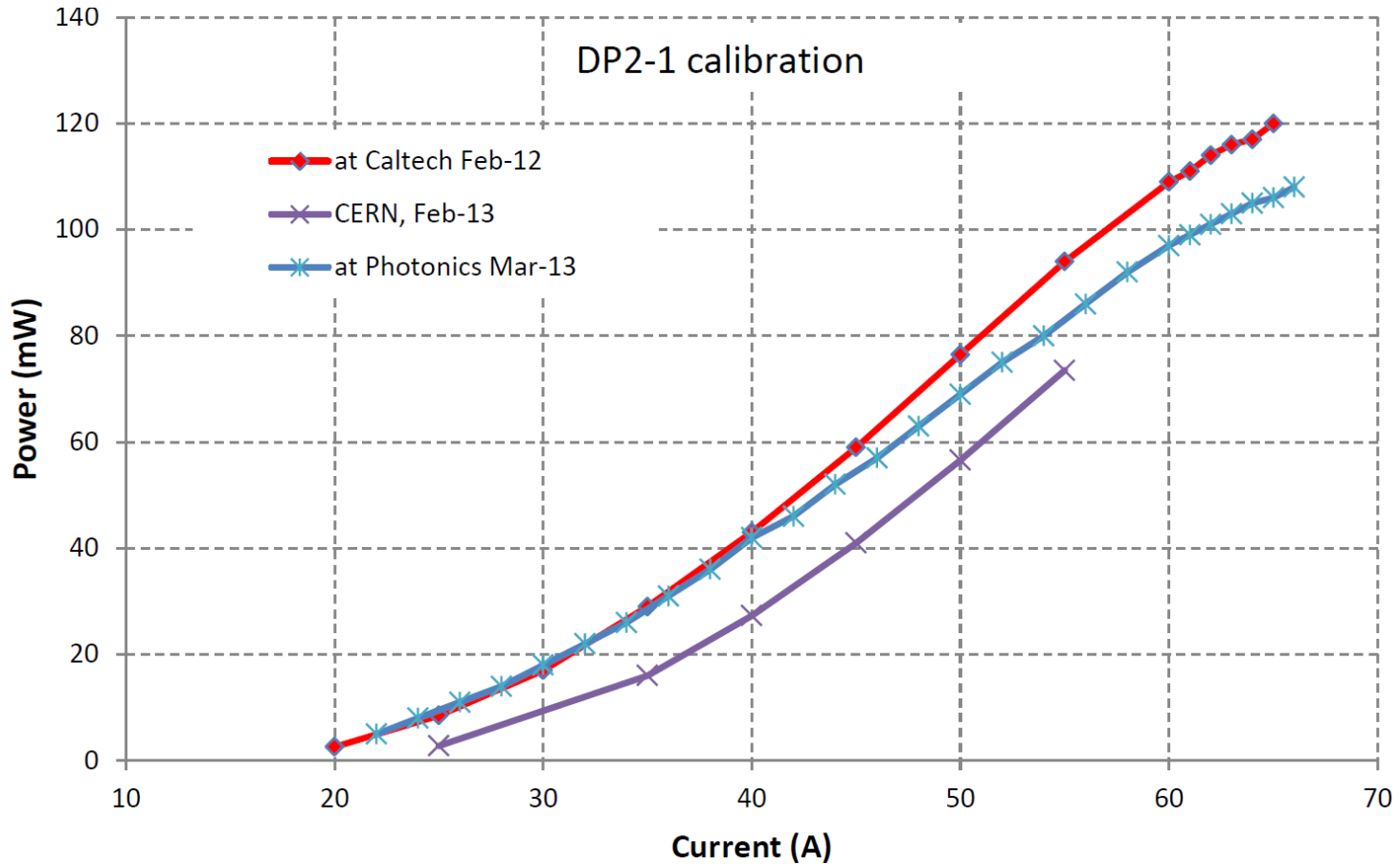

After replacing the THG crystal, the laser pulse energy met the specification of $>1\text{mJ}$ at 62 A. It, however, is still lower than that after the delivery. Graham claims this is probably due to degradation of other parts in system, but so far no other part was found to be terribly wrong.



List of Service Training

- ✓ Pump diode output power measurement.
- ✓ Pump diode replacement and practice.
- ✓ Change of maximal pump current limit.
- ✓ Q-switch driver diagnostic and replacement.
- ✓ Control and memory board replacement.
- ✓ Identifying optical components in the cavity.
- ✓ Fine tune the end mirror.
- ✓ Basic trouble shooting of the cavity.
- ✓ Identifying electrical components and sub-modules in the driver, and diagnostics of them.
- ✓ Load distribution in the driver.
- ✓ Power supply replacement.
- ✓ TEC board replacement.



Summary

- The coating of the THG crystal was found guilty for the power degradation of the 1st DP2 laser observed last summer. After replacing the crystal the pumping efficiency is increased significantly.
- The significant better pumping efficiency of the 2nd DP2 lasers is being investigated at Photonics. The pump efficiency of the 1st DP2 could be further improved, depending on the results of this investigation. If so, the life time of pumping diodes would be extended.
- The 2nd DP2 laser meets our spec as expected. A commercial chiller with both heating and cooling function is scheduled to be delivered next week. The 2nd DP2 system will be integrated and tested after the new chiller is arrived.
- Graham estimated that the two lasers will be ready to be delivered in 2 to 3 week. The formal reports for both lasers will be issued by then.